

TYPE: DAS0210

DIN Absperrschieber DN50 – DN600 PN16

DIN Gate Valve DN50 – DN600 PN16

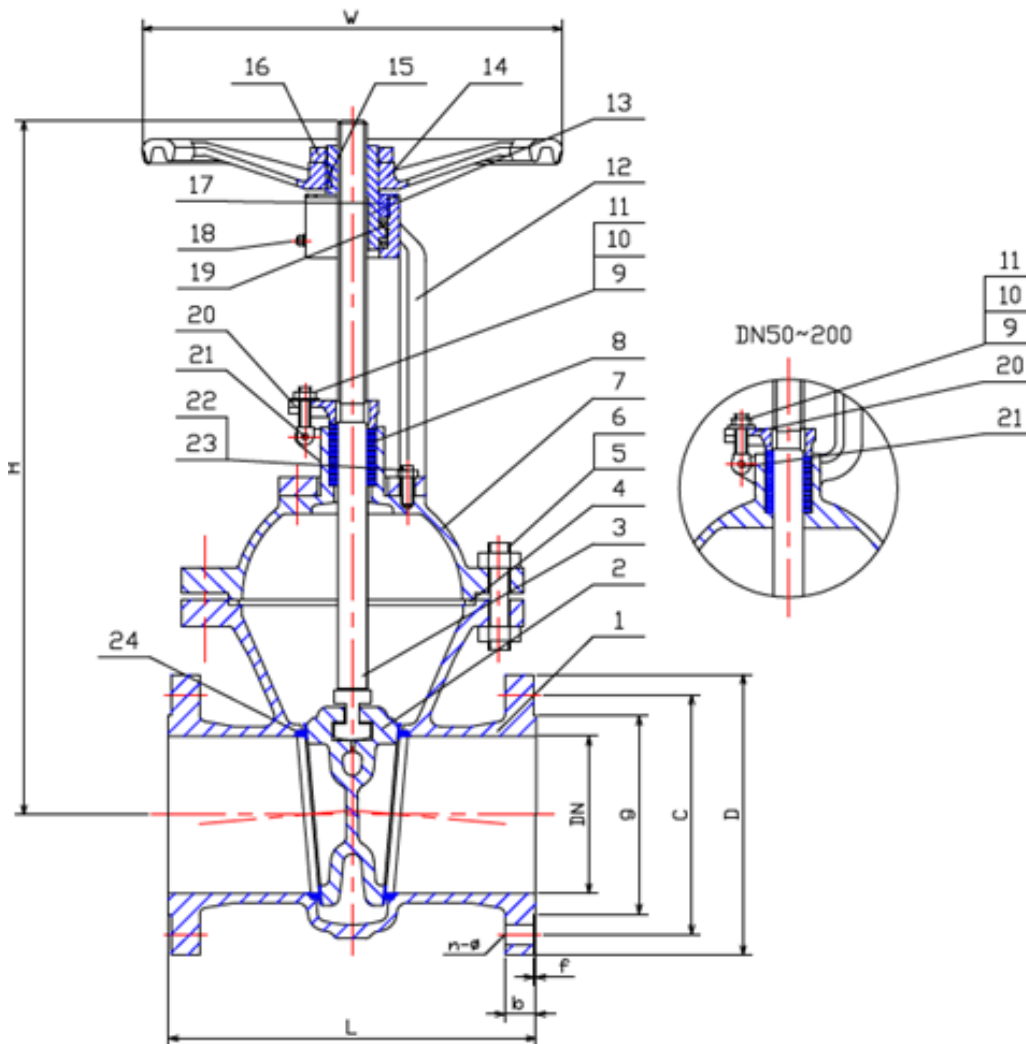

Technical Specification:

1. Design and machining acc. with EN1984
2. Inspection and test acc. EN12266-1
3. Face to Face acc. DIN3202-F5
4. Dimension of connection end flange acc. EN1092-1

DRW Industrietechnik GmbH

Bodenschwinger Str. 125

D-44357 Dortmund

Telefon: +49 2 31 - 92 71 44-0

info@drw-armaturen.de

www.drw-armaturen.de



Abmessungen / Dimensions:

DN	L	g	C	D	b	n-ø	f	W	H
50	250	102	125	165	20	4-18	3	200	325
65	270	122	145	185	18	4-18	3	225	365
80	280	138	160	200	20	8-18	3	225	405
100	300	158	180	220	20	8-18	3	250	475
125	325	188	210	250	22	8-18	3	360	560
150	350	212	240	285	22	8-22	3	400	645
200	400	168	295	340	24	12-22	3	400	800
250	450	320	355	405	26	12-26	3	450	945
300	500	378	410	460	28	12-26	4	500	1130
350	550	438	470	520	30	16-26	4	500	1260
400	600	790	525	580	32	16-30	4	600	1416
450	650	550	585	640	40	20-30	4	600	1588
500	700	610	650	715	36	20-33	4	720	1760
600	800	725	770	840	40	20-36	5	750	2030

Materialien / Materials:

No.	Part Name	Material
1	Body	1.4408
2	Wedge Disc	1.4408
3	Stem	1.4401
4	Gasket	1.4401 + Graphite
5	Studbolt	A4
6	Nut	A4
7	Bonnet	1.4408
8	Gland Packing	Graphite
9	Studbolt	A4
10	Nut	A4
11	Washer	1.4301
12	Yoke	1.4408
13	Yoke Sleeve	GGG - 40
14	Hand Wheel	GGG - 40
15	Key	1.4006
16	Lock Nut	1.4006
17	Bonnet Nut	1.4006
18	Grease Nipple	1.0402
19	Roll Axletree	Axletree Steel
20	Gland Foring	1.4408
21	Pin	1.4006
22	Studbolt	A4
23	Nut	A4
24	Seat Ring	1.4401 + Stellite

DRW Industrietechnik GmbH

Bodenschwinger Str. 125

D-44357 Dortmund

Telefon: +49 2 31 - 92 71 44-0

info@drw-armaturen.de

www.drw-armaturen.de

