

## TYPE: DAS0702

DIN Absperrschieber DN50 – DN150 PN160

DIN Gate Valve DN50 – DN150 PN160

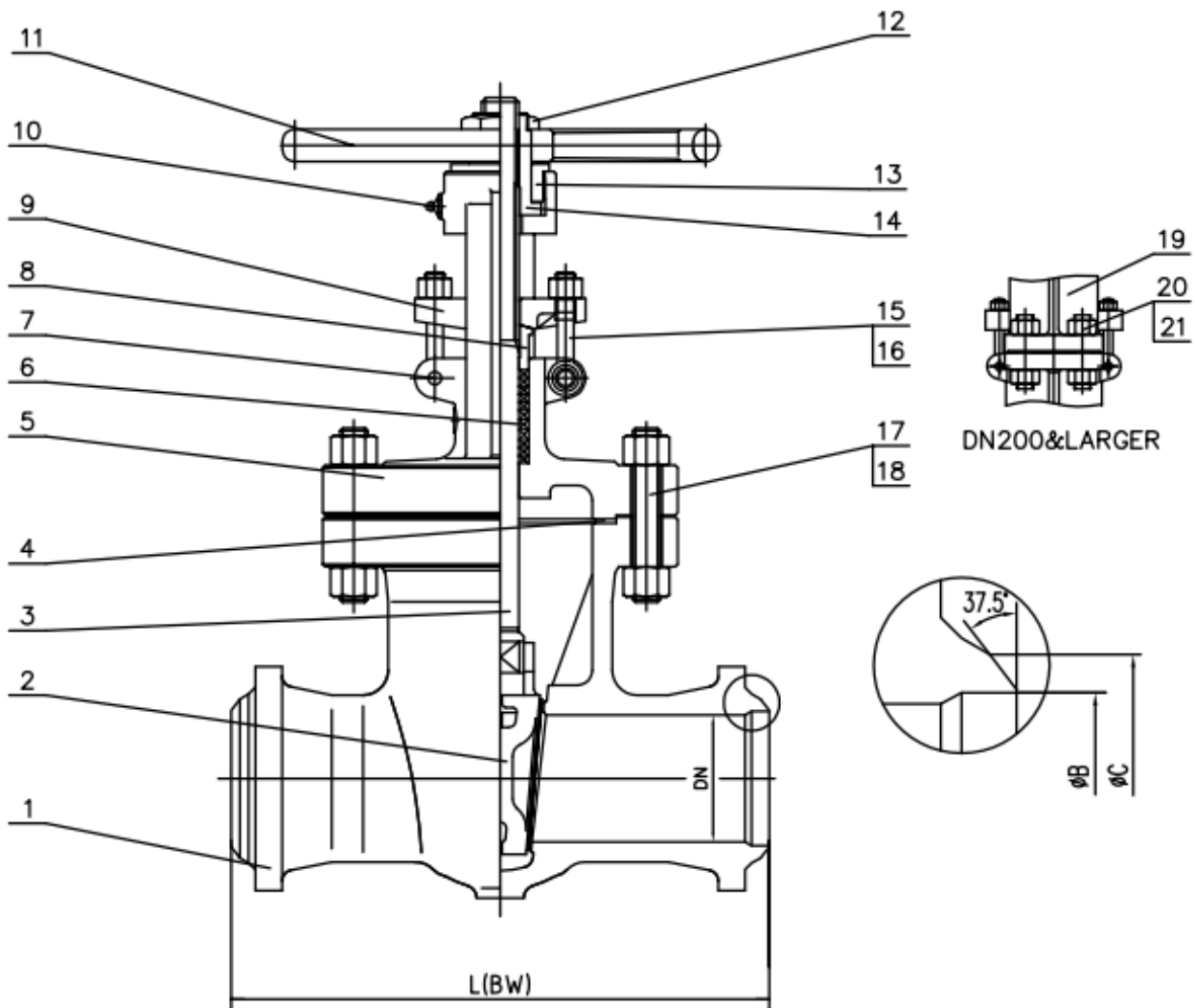

### Technical Specification:

1. Design and machining acc. with EN1984
2. Butt Welding EN12627
3. Face to Face acc. EN 12982 : GR 90
4. Test EN12266-1

### **DRW Industrietechnik GmbH**

Bodenschwinger Str. 125

D-44357 Dortmund

Telefon: +49 2 31 - 92 71 44-0

info@drw-armaturen.de

[www.drw-armaturen.de](http://www.drw-armaturen.de)



## Abmessungen / Dimensions:

DN	L	B	C
80	390	63.9	88.9
100	450	92.3	114.3
150	600	133.3	168.3
150	600	139.9	168.3
250	900	228.6	273

## Materialien / Materials:

No.	Part Name	Material
1	Body	1.0619 + STL
2	Wedge	1.0619 + STL
3	Stem	1.4401
4	Gasket	1.4401 + Graphite
5	Bonnet	1.0619
6	Packing	Graphite
7	Pin	1035
8	Gland	1.4401
9	Gland Flange	1.0619
10	Oil Cup	1.0501
11	Handwheel	Ductile Iron
12	Lock Nut	1.0501
13	Bearing Gland	1.0501
14	Yoke Nut	ASTM A439 D-2
15	Nut	YK
16	Gland Eyebolt	YK
17	Nut	YK
18	Bolt	YK
19	Yoke	1.0619
20	Nut	YK
21	Bolt	YK

### **DRW Industrietechnik GmbH**

Bodenschwinger Str. 125

D-44357 Dortmund

Telefon: +49 2 31 - 92 71 44-0

info@drw-armaturen.de

[www.drw-armaturen.de](http://www.drw-armaturen.de)

