

TYPE: DRK0310

DIN Rückschlagklappe DN50 - DN500 PN16

DIN Swing Check Valve DN50 - DN500 PN16

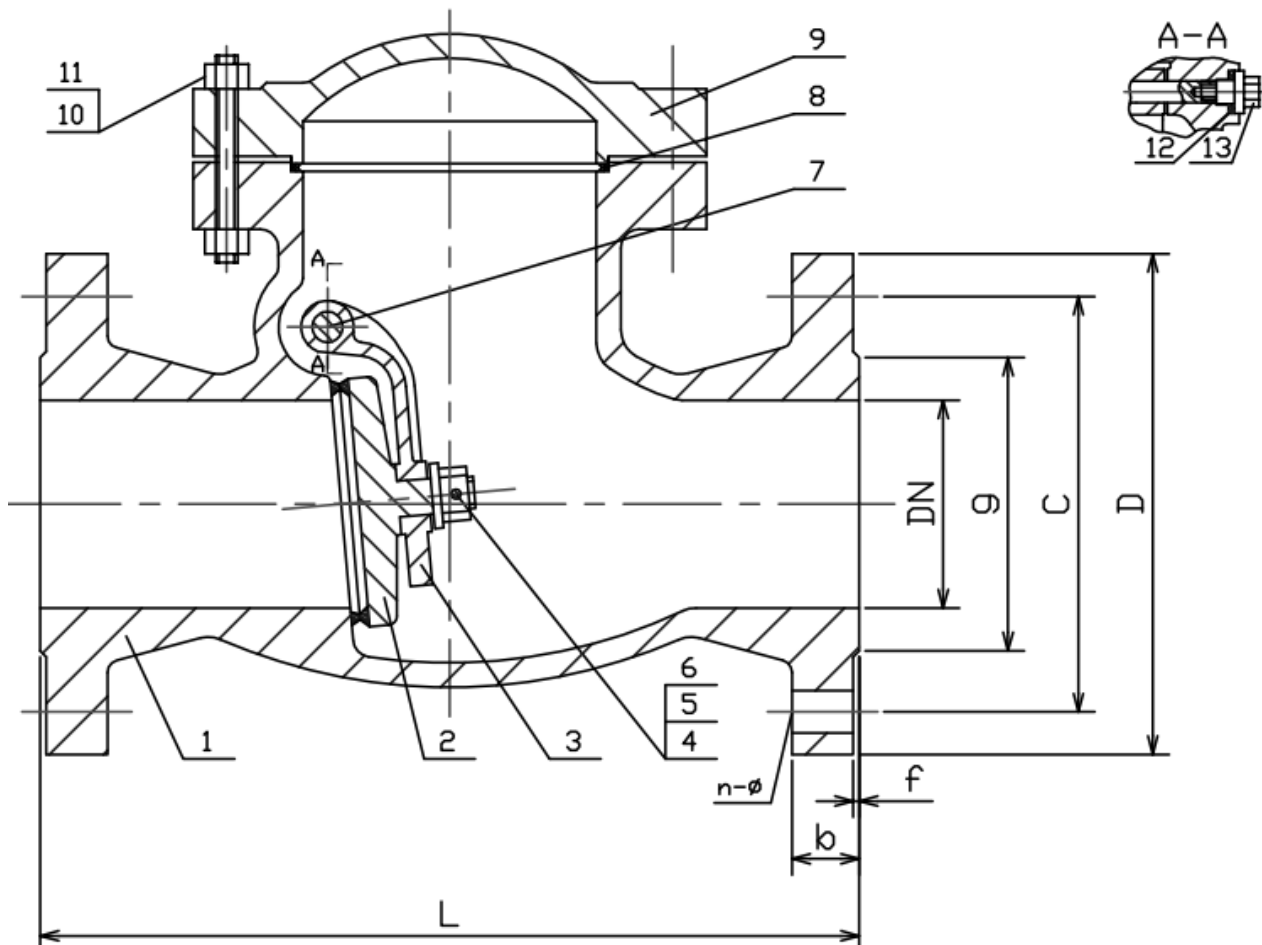

Technical Specification:

1. Design and machining acc. with EN14341
2. Inspection and test acc. EN12266-1
3. Face to Face acc. DIN3202-F1 (EN558-1 Gr.1)
4. Dimension of connection end flange acc. EN1092-1

DRW Industrietechnik GmbH

Bodenschwinger Str. 125

D-44357 Dortmund

Telefon: +49 2 31 - 92 71 44-0

info@drw-armaturen.de

www.drw-armaturen.de



Abmessungen / Dimensions:

DN	L	g	C	D	b	f	n-ø
50	230	102	125	165	20	3	4-18
65	290	122	145	185	22	3	8-18
80	310	138	160	200	24	3	8-18
100	350	162	190	235	24	3	8-22
125	400	188	220	270	26	3	8-26
150	480	218	250	300	28	3	8-26
200	600	278	310	360	30	3	12-26
250	730	335	370	425	32	3	12-30
300	850	395	430	485	34	4	16-30
350	980	450	490	555	38	4	16-33
400	1100	505	550	620	40	4	16-36
500	1250	615	660	730	44	4	20-36

Materialien / Materials:

No.	Part Name	Material
1	Body	1.4308 + STL
2	Disc	1.4308
3	Rocker	1.4308
4	Washer 1	1.4301
5	Nut	1.4301
6	Pin	1.4301
7	Hing Pin	1.4301
8	Gasket	1.4301 + Graphite
9	Bonnet	1.4308
10	Studbolt	A2
11	Nut	A2
12	Washer 2	1.4301
13	Plug Nut	1.4301

DRW Industrietechnik GmbH

Bodenschwinger Str. 125

D-44357 Dortmund

Telefon: +49 2 31 - 92 71 44-0

info@drw-armaturen.de

www.drw-armaturen.de

